



===== **CONTENTS** =====

1. INTRODUCTION.....	3
2. FEATURES	3
3. PIN ASSIGNMENT	3
4. BLOCK DIAGRAM	4
5. FUNCTION DESCRIPTIONS	4
5.1 OSCILLATOR	4
5.2 ROM	4
5.3 RAM	5
5.4 POWER DOWN MODE.....	5
5.5 SAMPLING RATE COUNTER	5
5.6 I/O PORTS	5
5.7 PWM OUTPUT	6
5.8 WATCH DOG TIMER.....	6
5.9 IR FUNCTION	6
6. ABSOLUTE MAXIMUM RATING	6
7. ELECTRICAL CHARACTERISTICS	7
8. APPLICATION CIRCUIT	8
8.1 GENERAL APPLICATION	8
8.2 MOTOR APPLICATION	9



AMENDMENT HISTORY

Version	Date	Description
Ver 1.0	Oct 30, 2007	First issue
Ver 1.1	May 28, 2008	Update Application Circuit
Ver 1.2	June 10, 2008	Refine Application Circuit
Ver 1.3	June 23, 2008	Refine Application Circuit
Ver 1.4	August 25 2008	Refine Application Circuit
Ver 1.5	October 30,2008	Refine Application Circuit



1. INTRODUCTION

SNC15120 is a one-channel voice synthesizer IC with PWM direct drive circuit. It built in a 4-bit tiny controller with four 4-bit I/O ports. By programming through the tiny controller in SNC15120, user's varied applications including voice section combination, key trigger arrangement, output control, and other logic functions can be easily implemented.

2. FEATURES

- ◆ Single power supply 2.4V – 5.5V
- ◆ 120 seconds voice capacity are provided (@6KHZ sample rate)
- ◆ Built in a 4-bit tiny controller
- ◆ I/O Port
 - Four 4-bit I/O ports P1, P2, P4 and P5 are provided.
 - The driving/sink current of P2 & P5 is up to 8mA/16mA
 - The IO pins P2.3 can be modulated with 38.5Khz carry signal to implement IR function.
- ◆ 128*4 bits RAM are provided
- ◆ Maximum 64k program ROM is provided
- ◆ 244K*12 shared ROM for voice data and program
- ◆ Readable ROM code data
- ◆ Built in one channel speech synthesizer
- ◆ Adaptive playing speed from 2.5k-20kHz is provided
- ◆ Built in an PWM circuit output, can directly connected to Speaker for sound output.
- ◆ System clock: 2MHz
- ◆ Event Mark function supported
- ◆ Low Power Detect.
- ◆ Watch Dog Timer Supported

3. PIN ASSIGNMENT

Symbol	I/O	Function Description
P10~P13	I/O	I/O port 1: IO
P20~P23	I/O	I/O port 2: IO
P40~P43	I/O	I/O port 4: IO
P50~P53	I/O	I/O port 5: IO
Rosc	I	Oscillation component connection pin
BUO1	O	PWM output 1
BUO2	O	PWM output 2
RST	I	RST=1 → Reset Chip (Active H)
VDDIO	I	Positive power supply for I/O
GNDIO	I	Negative power supply for I/O
CVDD	I	Positive power supply for internal core
CGND	I	Negative power supply for internal core
Test	I	Test pin

4. Block Diagram

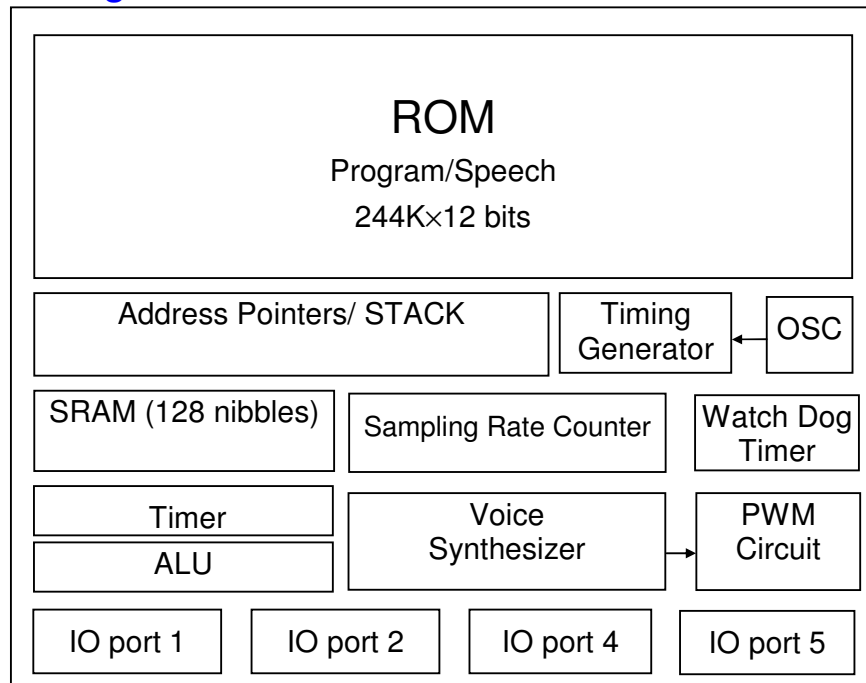

5. FUNCTION DESCRIPTIONS

5.1 Oscillator

SNC15120 accepts RC type oscillator for system clock. The typical circuit diagram for oscillator is listed as follows.

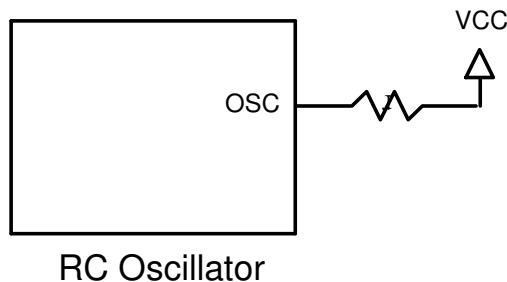

5.2 ROM

SNC15120 contains a substantial 244K words (12-bit) internal ROM, which is shared by program and resource data. Program, voice and data are shared within this same 244K words ROM.

5.3 RAM

SNC15120 contains 128 nibble RAM (128 x 4-bits). The 128 nibble RAM is divided into two pages (page 0 to page 1, 64 nibble RAM on each page). In our programming structure, users can use the instructions, PAGE n (n=0 to 1) to switch and indicate the RAM page. Besides, users can use direct mode, M0 ~ M63 in the data transfer type instructions, to access all 64 nibbles of each page.

5.4 Power Down Mode

“End” instruction makes the IC entering into Stop Mode will stop the system clock for power savings (<3uA @VDD=3V and <6uA @VDD=4.5V.) Any valid data transition (L→H or H→L) occurring on any IO pin can be used to start the system clock and return to normal operating mode.

5.5 Sampling Rate Counter

The unique sampling rate counter is designed in voice channel to be able to play diverse voices at different sample playing rates. The playing rate can be adaptively set up among from the wide ranges of 2.5KHz to 20KHz. This architecture yields a high-quality voice synthesis that sounds very close to its original source when played through the same amplifier and speaker circuitry.

5.6 I/O Ports

There are four 4-bit I/O ports P1, P2, P4, and P5. Any I/O can be individually programmed as either input pull low or output. Any valid data transition (H→ L or L→H) of P1, P2, P4, and P5 can reactivate the chip when it is in power-down stage.

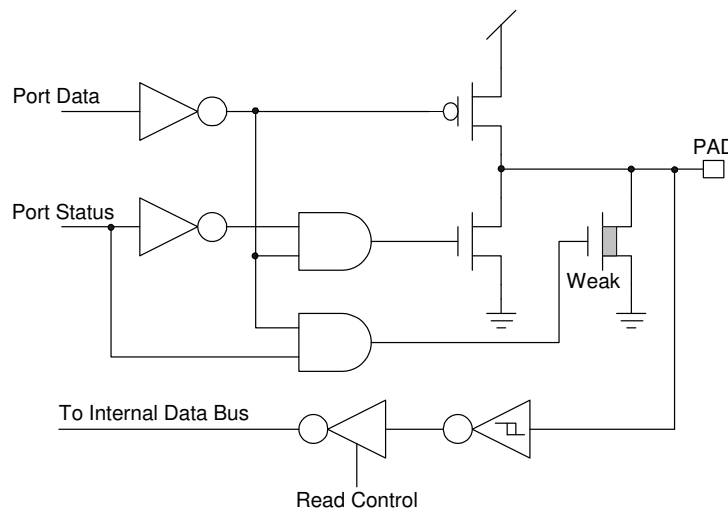

I/O Port Configuration

Note:

- (1) **Weak N-MOS can serve as pull-low resistor.**
- (2) **The driving/sink current of P2 & P5 is up to 8mA/16mA**

5.7 PWM Output

An PWM circuit is built-in SNC15120. The maximum resolution of PWM is 8 bits. Two huge output stage circuits are designed in SNC15120. With this advanced circuit, the chip is capable of driving speaker directly without external transistors.

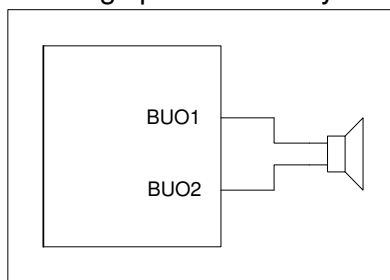

PWM Output

5.8 Watch Dog Timer

SNC15120 built an internal WDT (Watch Dog Timer). This Watchdog timer would issue resets signal to this chip if it is not cleared before reaching terminal count (1sec). The watchdog timer is enabled at reset and cannot be disabled.

5.9 IR Function

P23 can be modulated with 38.5KHz square wave before sent out to P23 pin. The IR signal can be achieved by this modulated signal.

6. ABSOLUTE MAXIMUM RATING

Items	Symbol	Min	Max	Unit.
Supply Voltage	V_{DD-V}	-0.3	6.0	V
Input Voltage	V_{IN}	$V_{SS}-0.3$	$V_{DD}+0.3$	V
Operating Temperature	T_{OP}	0	55.0	°C
Storage Temperature	T_{STG}	-55.0	125.0	°C



7. ELECTRICAL CHARACTERISTICS

Item	Sym.	Min.	Typ.	Max.	Unit	Condition
Operating Voltage	V _{DD}	2.4	3.0	5.5	V	
Standby current	I _{SBY}	-	-	3.0 6.0	μA	V _{DD} =3V, no load V _{DD} =4.5V, no load
Operating Current	I _{OPR}	-	300	-	μA	V _{DD} =3V, no load
Input current of P1, P2, P4, P5	I _{IH}	-	3.0	-	μA	V _{DD} =3V, V _{IN} =3V
Drive current of P1, P4	I _{OD}	3	4	-	mA	V _{DD} =3V, V _O =2.4V
Sink Current of P1, P4	I _{OS}	4	6	-	mA	V _{DD} =3V, V _O =0.4V
Drive current of P2, P5	I _{OD}	6	8	-	mA	V _{DD} =3V, V _O =2.4V
Sink current of P2, P5	I _{OS}	10	16	-	mA	V _{DD} =3V, V _O =2.4V
PWM current	I _{PP}	-	120	-	mA	V _{DD} =3V, Output 1K Sin wave.
PWM current	I _{PP}	-	150	-	mA	V _{DD} =4.5V, Output 1K Sin wave.
Oscillation Freq.	F _{OSC}	-	2.0	-	MHz	V _{DD} =3V

8. APPLICATION Circuit
8.1 General application

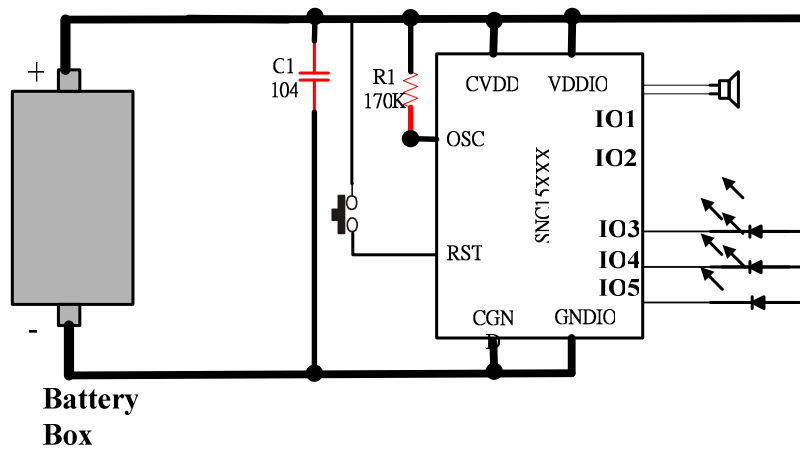

It is suggested to add a capacitor (C1), 104, between VDD with GND to keep power stable with general application. And this capacitor is strongly suggested to be as close to the chip as possible.

8.2 Motor application

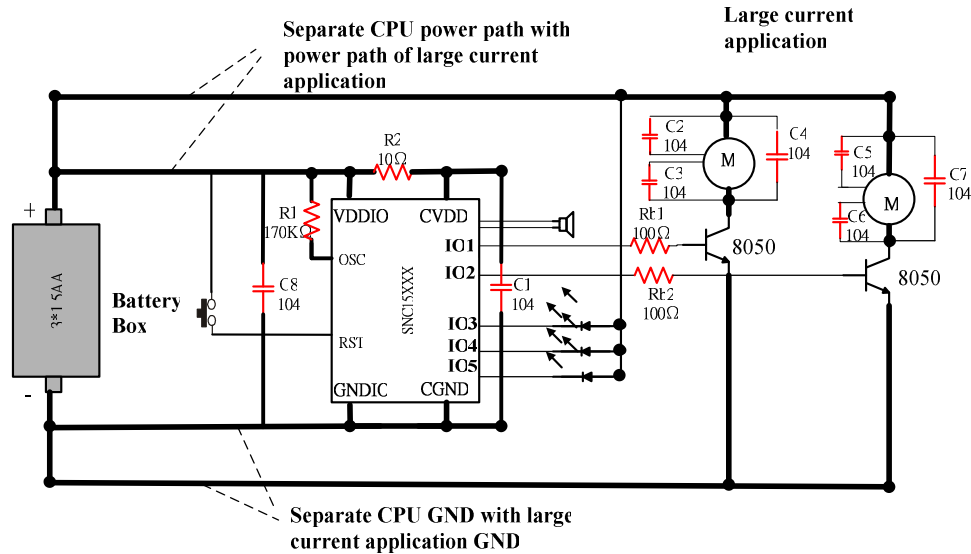

There are some suggestions about PCB layout when user use SNC15000 series IC with motor applications.

- (1) The capacitor C1 、C8 (104) is strongly suggested to be as close to the chip as possible.
- (2) It had better let OSC components (R) get close to IC chip.
- (3) OSC components had better get far away large current applications.
- (4) Separate IC power path with large current application power path to avoid affect IC working by power drop from large current application.
- (5) R2 (10Ω)separate VDDIO and CVDD.
- (6) Let power cable thicker, especially for large current application.
- (7) C2 、C3 、C4 and C5 、C6 、C7 (104) are connected at the shell of motor, positive point and negative point of the motor.



DISCLAIMER

The information appearing in SONiX web pages (“this publication”) is believed to be accurate.

However, this publication could contain technical inaccuracies or typographical errors. The reader should not assume that this publication is error-free or that it will be suitable for any particular purpose. SONiX makes no warranty, express, statutory implied or by description in this publication or other documents which are referenced by or linked to this publication. In no event shall SONiX be liable for any special, incidental, indirect or consequential damages of any kind, or any damages whatsoever, including, without limitation, those resulting from loss of use, data or profits, whether or not advised of the possibility of damage, and on any theory of liability, arising out of or in connection with the use or performance of this publication or other documents which are referenced by or linked to this publication.

This publication was developed for products offered in Taiwan. SONiX may not offer the products discussed in this document in other countries. Information is subject to change without notice. Please contact SONiX or its local representative for information on offerings available. Integrated circuits sold by SONiX are covered by the warranty and patent indemnification provisions stipulated in the terms of sale only. The application circuits illustrated in this document are for reference purposes only. SONiX DISCLAIMS ALL WARRANTIES, INCLUDING THE WARRANTY OF MERCHANTABILITY OR FITNESS FOR ANY PURPOSE. SONiX reserves the right to halt production or alter the specifications and prices, and discontinue marketing the Products listed at any time without notice. Accordingly, the reader is cautioned to verify that the data sheets and other information in this publication are current before placing orders.

Products described herein are intended for use in normal commercial applications. Applications involving unusual environmental or reliability requirements, e.g. military equipment or medical life support equipment, are specifically not recommended without additional processing by SONiX for such application.